

PNEUMATIC



- 0452130 MT 3-Button Assembly
- 0452129 MT 2-Button Assembly



- 0451132 MT 3-Button Face Plate

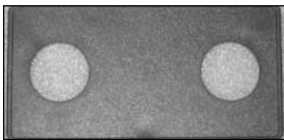

- 0451131 MT 2-Button Face Plate

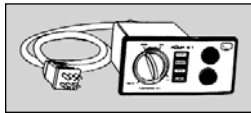

- 0452123 DX 2-Button 110V (DX10A, D15, D10)
- 0452124 DX 2-Button 220V (DX15, D26)

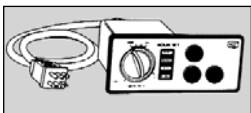

- 0452125 DX 3-Button 220V (DX30, D26, D40, DX53A, DE2053B, DE1553B)

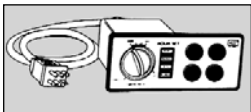

- 0452126 DX 4-Button 220V (D53, D80D60, De4054B, DE3054B)

DECALS



- 0452122 2-Button



- 0452128 3-Button



- 0452127 4-Button

LABELS



- 0461529 VitAroma w/Silver and Blue Label



- 0461528 3 Way Valve Label  
N / A Waterfall Valve label

- 0461535 Air Control Label

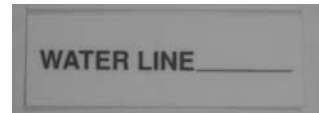

- 0461523 Water Fill Decal

ACCESSORIES



- 0452141 Replacement Air Button for MT2B

- 0452150 1/4" Clear Tubing - 100 Ft

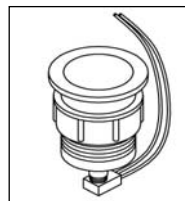

- 0452158 Replacement Air Button  
for use with #451130-2,3 BLK Fiber Optic

- 0452157 Air Button Duet GRY

- 0452140 Air Button White 3" inground spa

- 0210112 Trim Deco Ring

**ELECTRONIC SPA SIDE CONTROLS**



**0460126-05**      Graphic Spa Side w/Rock  
Use 0460126-05K      ('05-Present) See Page 29



**0460074**      Analytical LC500/L700C ('02-'04)  
**0460078**      SR5 3 3Pump ('04-Present)  
**0460078-X**      Analytical Export L700c



**0460122-05**      Analytical Spa Side 100 & 200  
**0460122-05X**      Analytical Export 100 & 200  
('06 -Present)



**0460073**      Analytical Spa Side L200  
('02-Present)



**0460072**      Analytical Spa Side L100  
('04 -Present)



**0460087**      Spa Side L/LC500 ('98-'01)



**0460086**      Spa Side L200 ('98-'01)



**0460085**      Spa Side L100 ('98-'01)

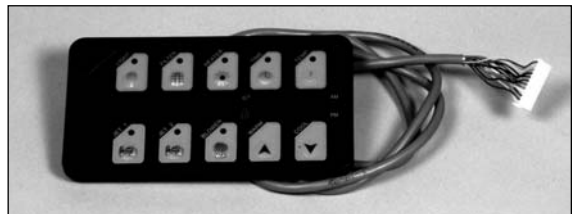

**LX-LC400**      ('93-'95) 1995 Hi Beze  
LX400 Spa Side



**LX-LC40096**      ('96 To '97) 1996 Low Bezel  
LX400 Spa Side

ELECTRONIC SPA SIDE CONTROLS



0460126-05K      Graphic Spa Side 5' (KIDN '06)



0460130-05      Vita Spa Graphic Spa Side 5'  
(DreamPack/ICS)



0460131-V05      ICS 5' Spa side  
0460131-V05X      ICS 5' Spa side  
(Export)

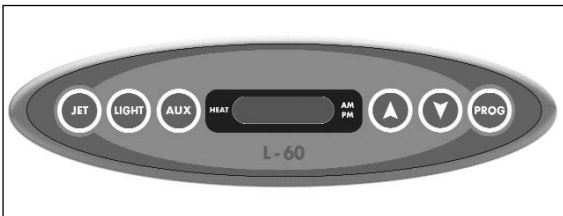

0460132-V05      Vita Spa S-PACK 5' Spa side  
0460132-V05X      Vita Spa S-PACK 5' Spa side  
(Export)

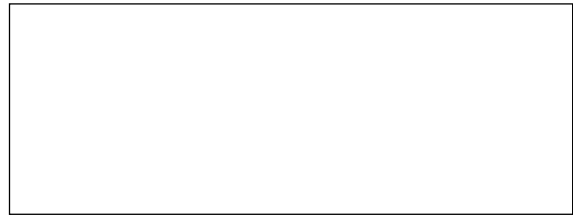

0460131-R05      Reflections D-PACK 5' Spa side  
0460131-R05X      Reflections D-PACK 5' Spa side  
(Export)



0460129      Wellma 5' Spa side



0460128      Tranquility 5' Spa side\

**TOP SIDE CONTROLS & ACCESSORIES**

**ELECTRONIC SPA SIDE CONTROLS**



0451105 LV15



0460098 L50 / Universal Spaside  
0460119 w/ 25' Cord Spaside  
0460120 w/ 50' Cord Spaside



0451127 LD15

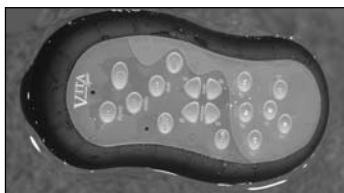

0460125-VT Floating Remote F/ Vita

**REMOTE SPA SIDES**



0460076-L05 Vita Remote (6 Button)  
0460076-L05X Vita Export Remote



LX-LR500 Remote



0460076 Analytical Spaside Remote



0460111 Spa Side Wave Seat



**TO ORDER**

USE PART NUMBERS WHEN ORDERING

Fax (305) 685-2671

**TOP SIDE CONTROLS & ACCESSORIES**

**REFLECTIONS**



LXR100SS Spa Side R100



LXR200SS Spa Side R200



0460124-05 Spa Side R600-R700 (2005 Model)

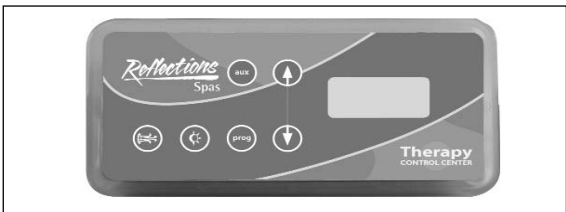

0460123-05 Spa Side R100/200



0460076-R05 Reflections Remote

**SPA-LINC**



- 0460095 1. Wired Spa-Linc Kit
- 0460089 2. Spa-Linc Interface
- 0460090 3. Spa-Linc Software (CD)
- 0451429 4. Telephone line 150'
- 0460094 5. Cable serial port 9 PIN

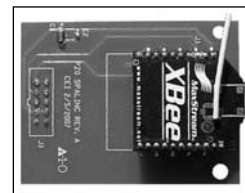

0451160-D D-Pack Wireless Module Board

SWITCHES

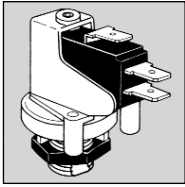

0452132 2 Function On/Off Air Switch

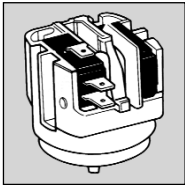

0452103 4 Function Air Switch

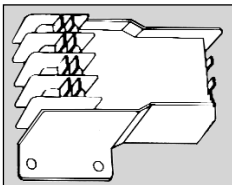

0452101 4 Function TDI 110v (CSC 1103/1203)  
0452102 4 Function 220V (CSC 1246)

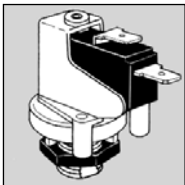

0452110 Air Sensor (Momentary Switch)  
for TDI 110V/220v 4 Function



0411106 Adjustable Pressure Switch



0411029 Flow Switch

TIMERS

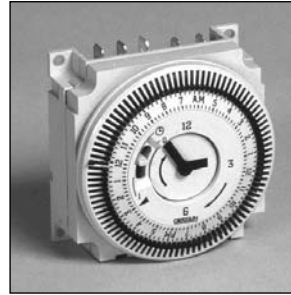

0460512 110V 60Hz Grasslin  
0460513 220V 60Hz Grasslin  
0460514 220V 50Hz Grasslin

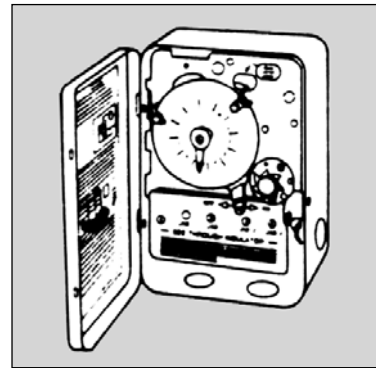

0460515 220V Weatherproof  
(T104)

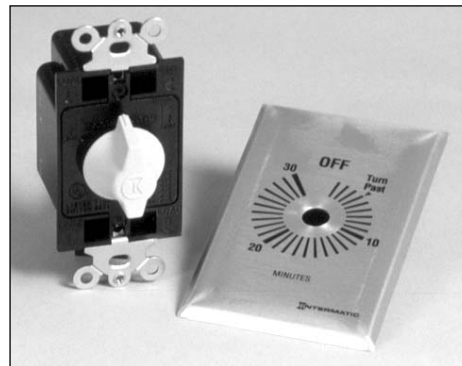

0560907 30 Min. Spring Wound  
(Whirlpool)

**TERMINAL BLOCKS, GROUND LUGS, BUSS BAR, THERMOSTATS**

**TERMINAL BLOCKS,  
GROUND LUGS, BUSS BAR**

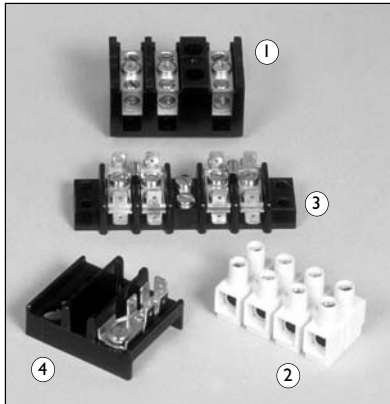

- 0460811                      1. Terminal Block Ed-3
- 0460810                      2. Terminal Block WECO E Box
- 0460820                      3. Terminal Kulka 60
- 0460812                      4. Common/Neutral Block

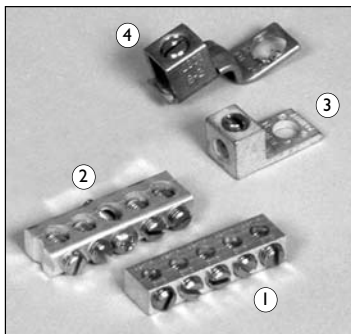

- 0460205                      1. Ground Bar for 50/60A GFCI
- 0460830                      2. Ground Buss Bar 390101
- 0460831                      3. Ground Lug Alu. 6-14 DRSLIC-6
- 0460832                      4. Ground Lug Pump Copper #8-2



- 0460816-3                      Terminal Block 3 POS Scrw+QDIS

**THERMOSTATS**



- 0451150                      Capillary for DX Spa Side



- 0411017                      Capillary for MT PACS



- 0411010                      Hi-Limit Thermo Disk



- 0411011                      Capillary High Limit

- 0411018                      Thermostat Knob

STEREO COMPONENTS  
MODEL YEAR 2003+



0453152-CVR 06+ CD Box Cover Low Profile



0453146 Small Cover Only 04+  
0453147 Small Stereo Housing 04+



0453117 Stereo Housing 03

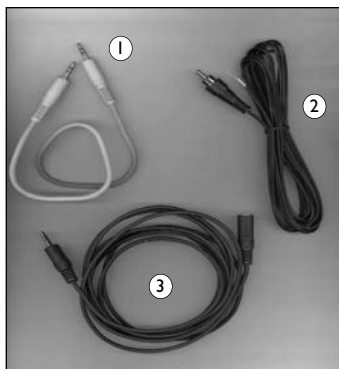

0461769 1) Male to Male Cable  
0461976 2) Cable 8' RCA Type "C"  
0461770 3) 3mm Stereo Cable

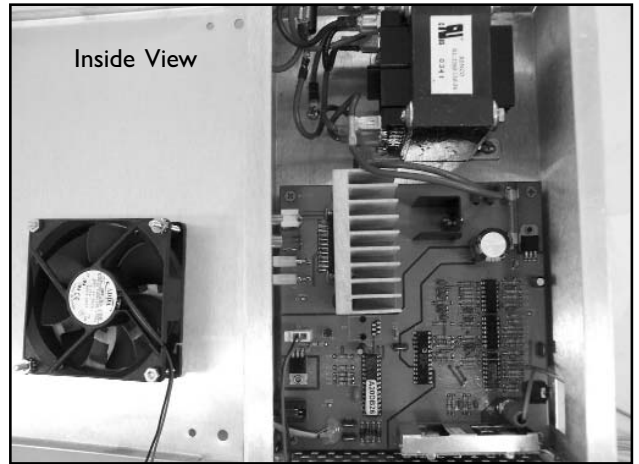

0453150 Stereo Box ONLY

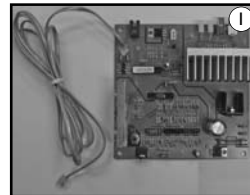

0453132  
0453133

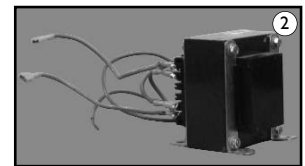

1) Circuit Board  
2) Transformer

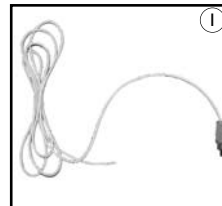

0453135  
0453134

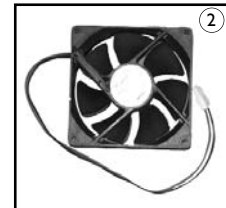

1) Antenna  
2) Fan

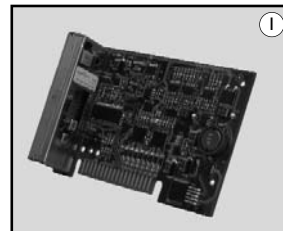

0451159-D  
0453153

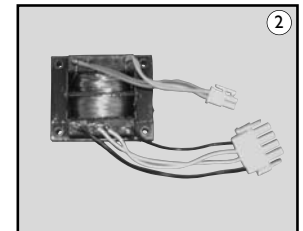

1)D-Pack Stereo Circuit Board  
2)D-Pack Stereo Transformer

STEREO COMPONENTS  
MODEL YEAR 2003+



0453130 Woofer  
0453136 Woofer Connectors/with Terminals  
0453129 CD Player



0453155 Stereo\_08 Speakers 6in GPH POPUP



0453154 Stereo\_08 Speaker 3in GPH

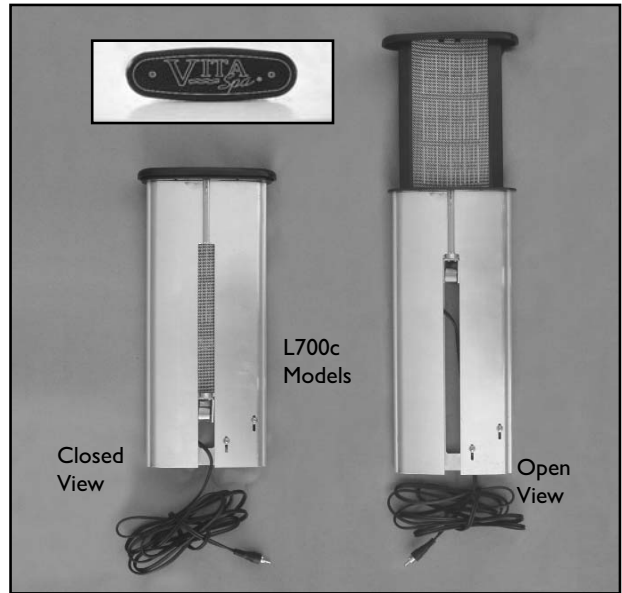

0453107 Speaker (sold as pair)  
0461778 Wire Connectors

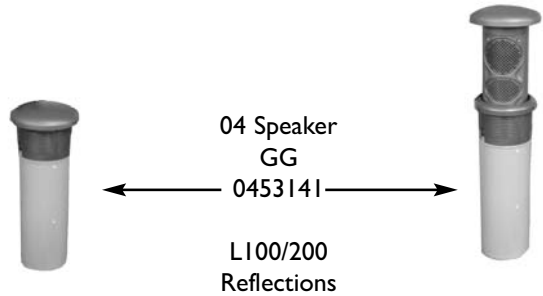

TRANSFORMERS

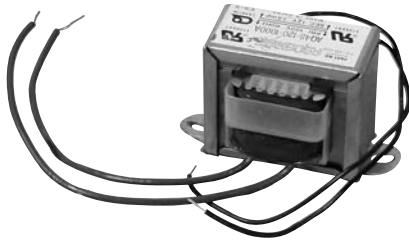

DX/MT Light Transformer

0442201

110V 50/60Hz (Portable Packs)

0442202

220V 50/60Hz (Portable Packs)

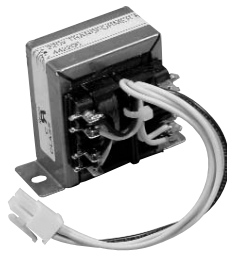

0442206

L500/200/100 220v/12v 8 Pin

LX-LT500

L500/200/100 220v/12v 4 Pin

0442205

L500/200/100 110v/12v 8 Pin

LX-LT501

L200/100 110v/12v 4 Pin



Transformer Duet/Voyager

0442203

110v/12v 1Amp 8PIN

0442204

220v/12v 1Amp 8PIN

TRANSFORMER ADAPTER

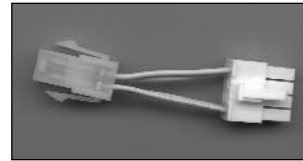

Transformer to Board

← 4 Pin to 8 Pin

0442207

Transformer Adapter 4 to 8 Pin

0442208

Transformer Adapter 8 to 4 Pin

OTHER TRANSFORMERS

LX-LT400

LX400 220v/12v

TRANSFORMER FOR STEREO

0461470

12v for Spa Stereo

INGROUND TRANSFORMERS

0445005

Transformer Inground 220v/12v

VOYAGER COMPONENTS

PACK PARTS

- 0615100 Therapy Module
- 0615101 Export Therapy Module
- 0469583 Pack LV15 Complete
- 0468596 Pack LV15 Box/Heater only
- 0467587 Pack LV15 Box only
- 0469584 Export LV 105
- 0469559 Export Pack BAV15
- 0420431 Pump & Motor only
- 0422102 Motor only
- 0423013 Wet End only
- 0451105 Spa Side
- 0451104 Circuit Board
- 0442203 Transformer
- 0411093 Heater Assembly
- 0411106 Pressure Switch
- LX-LP500 Pressure Switch Sensor
- 0460904 Power Cord

PLUMBING

- 0212305 Filter
- 0212602 Filter Bottom Fitting
- 0210701 Pulsator Jet
- 0210221 Swim Jet
- 0210141 Mini Jet
- 0211016 Primer (Air Control)
- 0212043 3-Way Valve Assembly
- 0411054 Heater Split Nut Union
- LX-LW500 Water Temp Sensor
- 0451126 Heater Temp Sensor

COMPONENT PARTS

- 0610120 Cover
- 0632012 Foam Pad
- 0615103 Strap Assembly
- 0461014 Strap only
- 0461488 Turn Buckle only
- 0615001 Wall Section
- 0615000 Bench
- 0615002 Retaining Rod
- 0222603 Module Trim
- 0615200 Vinyl Liner
- 0420104 Foot Pump for Cover
- 0610129 Winter Cover Kit Brwn
- 0610130 Winter Cover Kit Gry

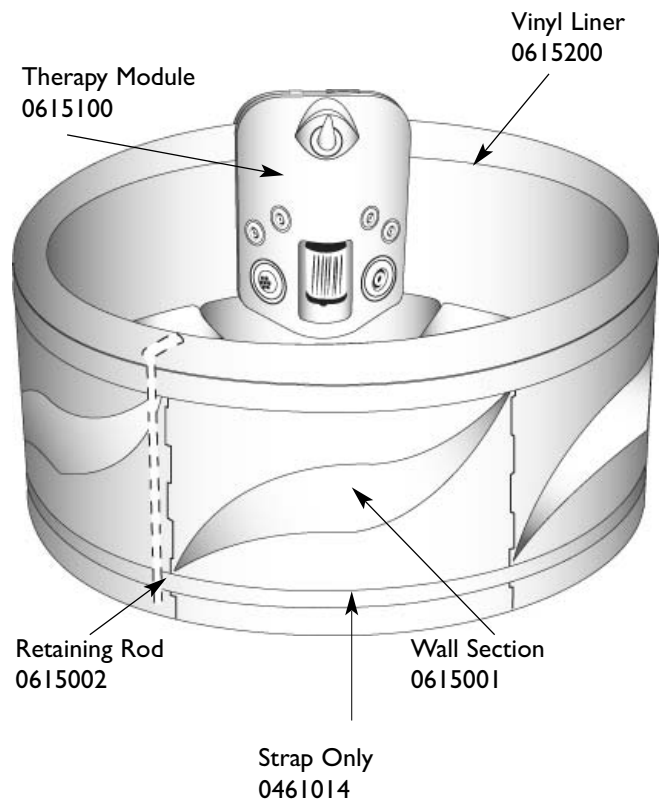
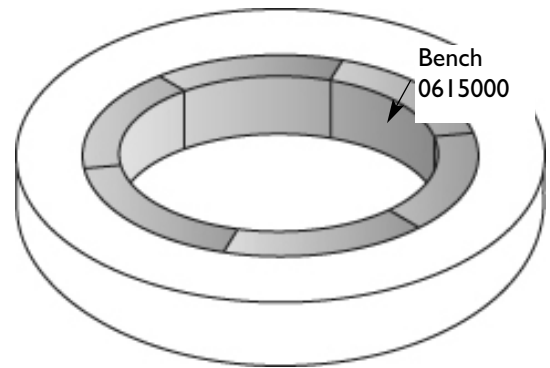
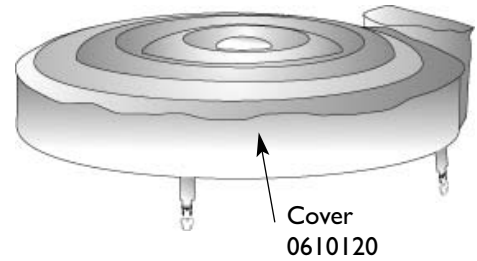

To Purchase Accessories go to <http://www.showerandspashop.com>

Jan. 08



TO ORDER

USE PART NUMBERS WHEN ORDERING

Fax (305) 685-2671

**VOYAGER THERAPY MODULE**

VOYAGER THERAPY MODULE

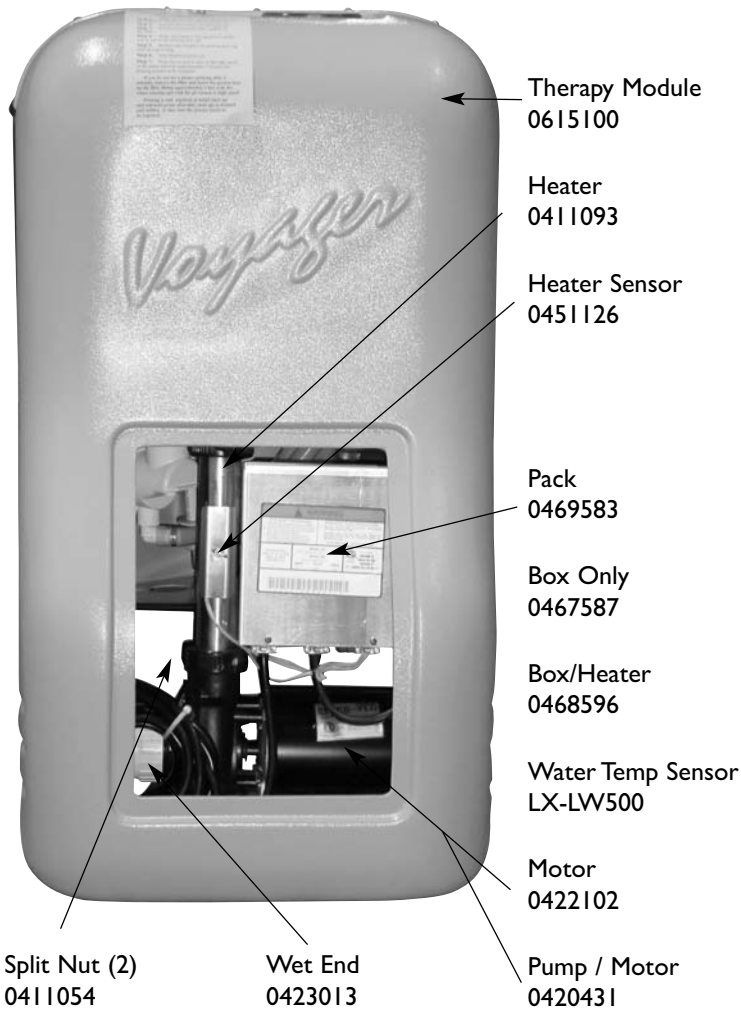

Split Nut (2)  
0411054

Heater  
0411093

Heater Sensor  
0451126

Wet End  
0423013

Power Cord  
0460904

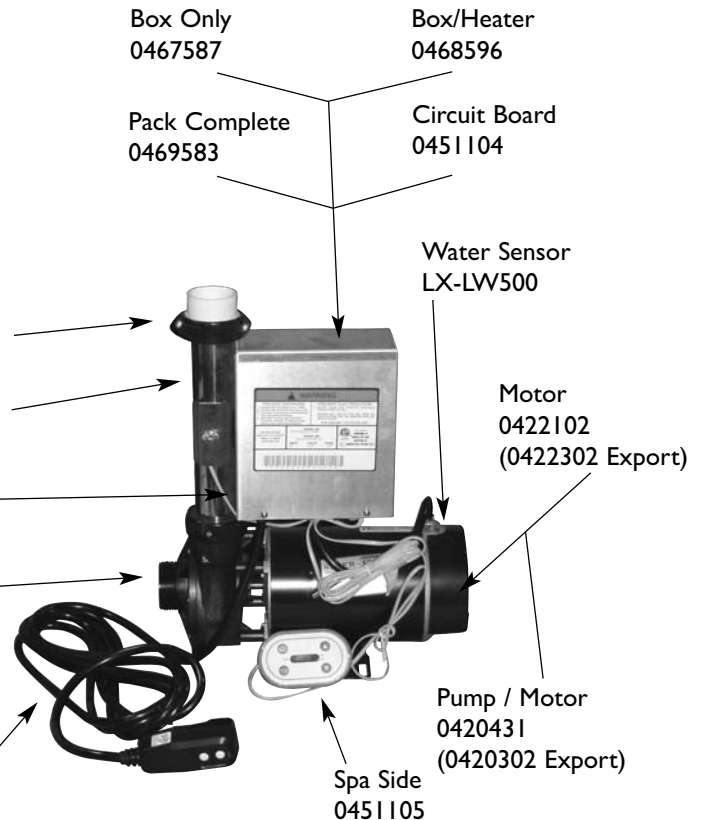

TO ORDER

USE PART NUMBERS WHEN ORDERING

Fax (305) 685-2671

Jan. 08

**VOYAGER THERAPY MODULE**

VOYAGER THERAPY MODULE

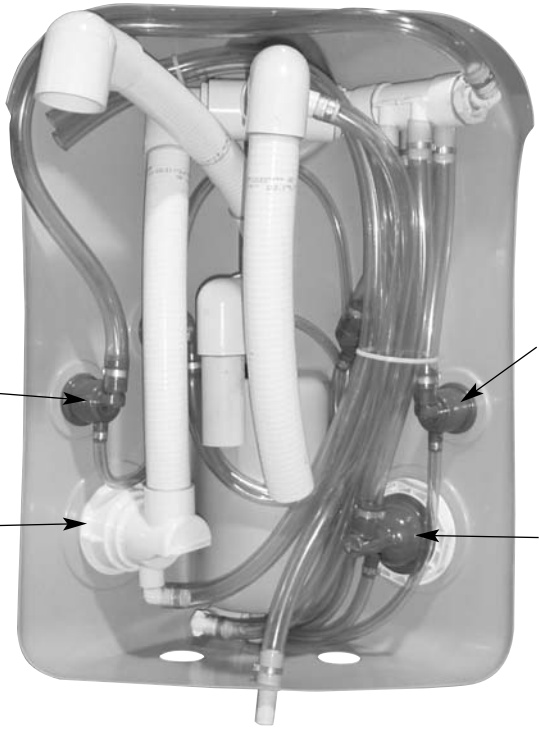
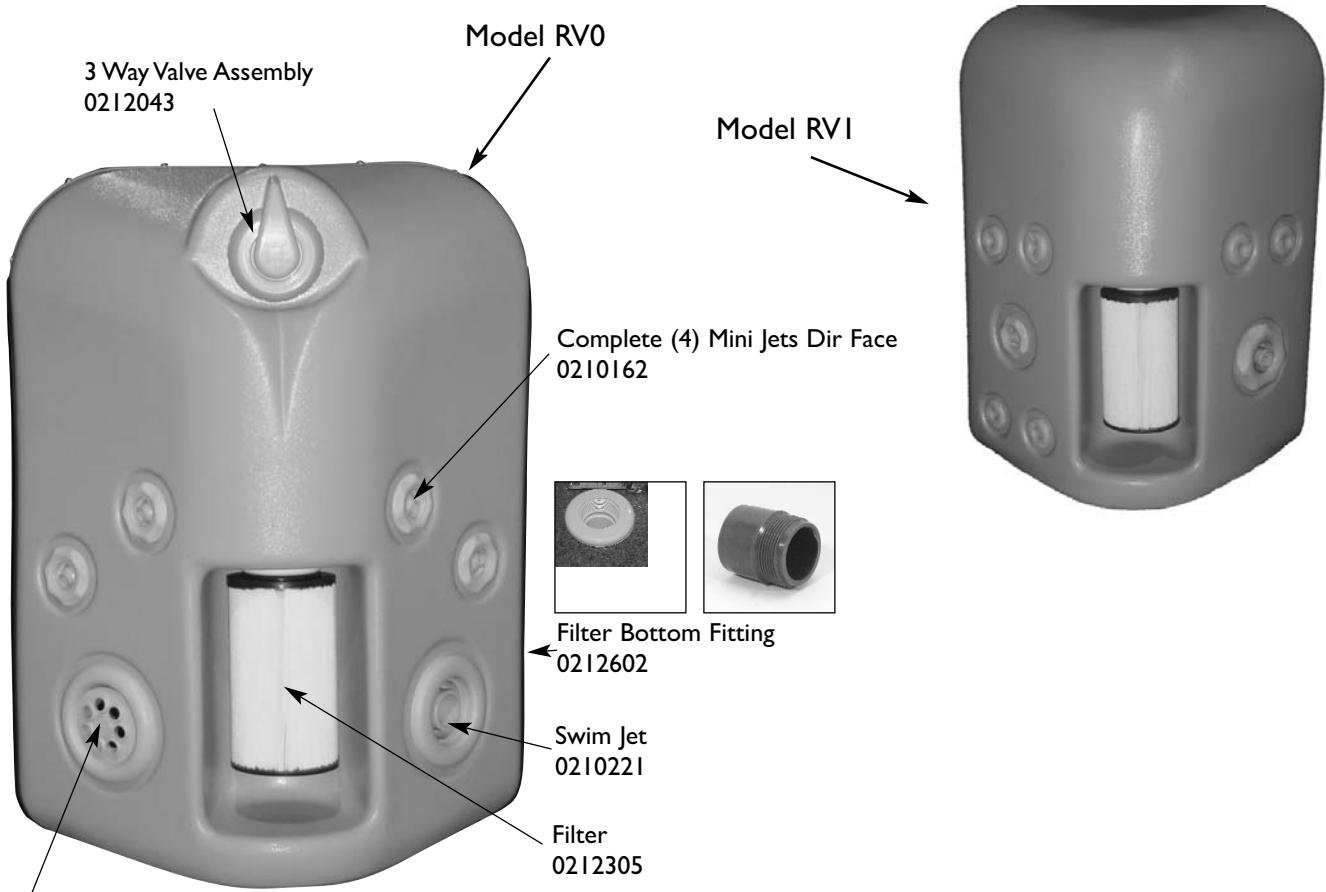

Mini Jet Complete  
0210141  
Mini Jet Body  
0210128

Swim Jet  
0210221

Mini Jet Complete  
0210141  
Mini Jet Body  
0210128

Pulsator Jet  
0210706



TO ORDER

USE PART NUMBERS WHEN ORDERING

Fax (305) 685-2671

Jan. 08

VOYAGER II COMPONENTS

EXPORT PARTS

Therapy Module Complete (Export)	0615106
Complete Pack (Export) LVE10	0469656
Pack Box/Heater (Export) LVE10	0468656
Pack Box (Export) LVE10	0467656
Motor 2SP 1HP 220V/50H (Export)	0422329
Transformer 220/12 1A 8P (Export)	0442202
Heater FLO-THRU 1.5KV 240V (Export)	0411091

PACK PARTS

Therapy Module Complete	0615105
Complete Pack LV10	0469655
Pack Box/Heater LV10	0468655
Pack Box LV10	0467655
Wet End Spa 3/4 HP Voyager	0423039
Motor 2SP 1HP 110V/60H	0422329
Spa Side Voyager	0451105
Board LV15 Voyager	0451104
Sensor Heater Temp 5 ftL5/2/1 SE	0451126
Pressure Switch 2 PSI.	0411106
Transformer 110/12 1A 8P	0442203
Heater FLO-THRU 1KW @110V	0411093
Recep.Ozonator MP BK 110/220	0460922
Power Cord 14/3-15' W/15A GFCI	0460904

COMPONENT PARTS

Gasket for Voyager Heater	0461134
Union Gasket 1 1/2" (pump side Wht)	0423018
Union Gasket 1 1/2" (heater side Blk)	0423012

FUSE 10 AMP FOR BLOWER	0452155
FUSE HOLDER INLINE	0452154
STANDOFF PCB 7/8" DUAL LOCK	0461348

CONNECTOR ROMEX 3/4	0421015
SCREW SM PH PAN "A" 6 X 3/8(Voy)	0461426

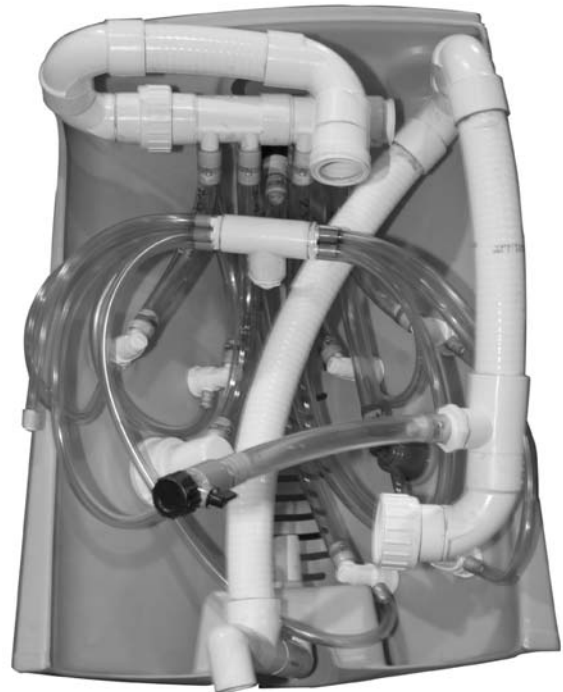
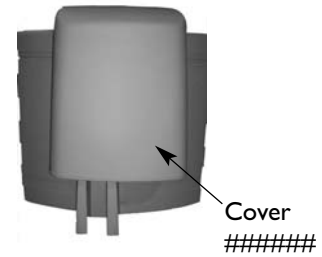

To Purchase Accessories go to <http://www.showerandspashop.com>

Jan. 08



TO ORDER

USE PART NUMBERS WHEN ORDERING

Fax (305) 685-2671

VOYAGER II COMPONENTS

